



Dieffenbach
56-001-03
3.5cm/1½"
56-001-05
5cm/2"



Dieffenbach
56-002-03
3.5cm/1½"
56-02-05
5cm/2"

Straight

For Bulldog Clamps

- 56-005-01 38mm/1 ½
- 56-005-02 51mm/2"
- 56-005-03 57mm/2 ¼
- 56-005-04 63mm/2 ½
- 56-005-05 70mm/2 ¾
- 56-005-06 75mm/3"
- 56-005-07 90mm/3 ½



Curved

- 56-006-01 38mm/1 ½
- 56-006-02 51mm/2"
- 56-006-03 57mm/2 ¼
- 56-006-04 63mm/2 ½
- 56-006-05 70mm/2 ¾
- 56-006-06 75mm/3"
- 56-006-07 90mm/3 ½



Dieffenbach
56-003-06
6cm/2½"



Dieffenbach
56-004-06
6cm/2½"

Johns-Hopkins



Johns-Hopkins
56-007-24
24.5cm/9¾"

Haemorrhoidal Clamps



Carrel
56-008-10
10cm/4"



Chaput
56-009-13
13cm/5"

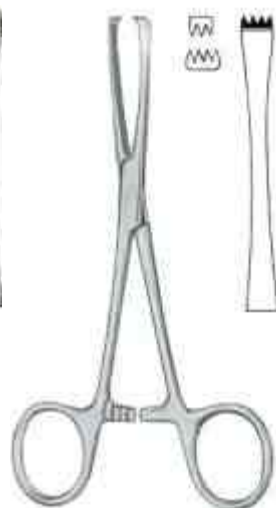

Tuffier
56-010-13
13cm/5"



Pratt
56-011-15
15cm/6"



Terrier
56-012-10 15 cm/6"
56-012-11 10 cm/4"



Pennington
56-013-15 15 cm/6"
56-013-20 20 cm/8"



Peau
56-014-12 12.5 cm/5"

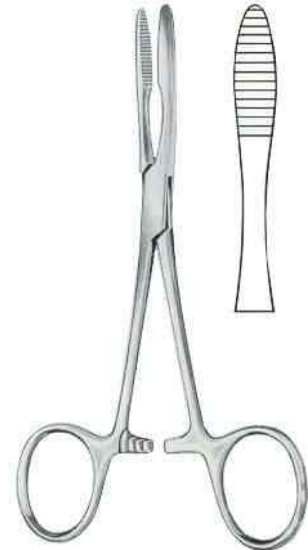

Peau
56-015-14 14 cm/5 3/4"
56-015-16 16 cm/6 1/4"



Peau
56-016-14 14 cm/5 1/2"



Collin
56-017-15 15.5 cm/6"



Collin
56-018-14 14 cm/5 1/2"



Collin
56-019-16 16.5 cm/6 1/2"



Hartmann
10 cm/4"



56-020-10



56-021-10



56-022-10



56-023-10



Halstead-Mosquito
12 cm/4¾"
14 cm/5½"



56-024-12
56-024-14



56-025-12
56-025-14



56-026-12
56-026-14



56-027-12
56-027-14



Micro-Mosquito
10 cm/4"
12 cm/4¾"



56-028-10
56-028-12



56-029-10
56-029-12



56-030-10
56-030-12



56-031-10
56-031-12



Jacobson-Halstead
13 cm/5"



56-032-13



56-033-13

Very fine



Cross serrations

56-034-12
12 cm/4¾"



Halstead-Mosquito
18 cm/7"
21 cm/8¼"



56-035-18
56-035-21



56-036-18
56-036-21



56-037-18
56-037-21



56-038-18
56-038-21



Kelly
14 cm/5½"

Kelly-Rankin

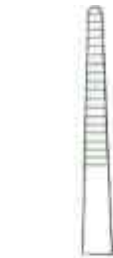

56-039-14



14 cm/5½" 56-040-14

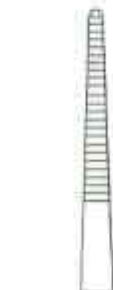

56-041-16



16 cm/6¼" 56-042-16



Crile
14 cm/5½"

Crile-Rankin
16 cm/6¼"



56-043-14



14 cm/5½" 56-044-14



56-045-16



16 cm/6¼" 56-046-16



Baby-Crile
14 cm/5½"



56-047-14



56-048-14



Crile
14 cm/5½"

Crile-Rankin
16 cm/6¼"

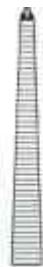

56-049-14



14 cm/5½" 56-050-14



56-051-16



16 cm/6¼" 56-052-16



Baby-Crile
14 cm/5½"



56-053-14



56-054-14



Coller-Crile



56-055-14



14 cm/5 1/2" 56-056-14



56-057-16

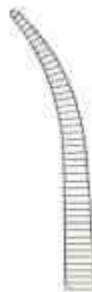

16 cm/6 1/4" 56-058-16



Coller-Crile
56-059-16
16 cm/6 1/4"



Leriche
15 cm/6"



56-060-15



56-061-15



56-062-15



56-063-15



Providence
14 cm/5 1/2"



56-064-14



56-065-14

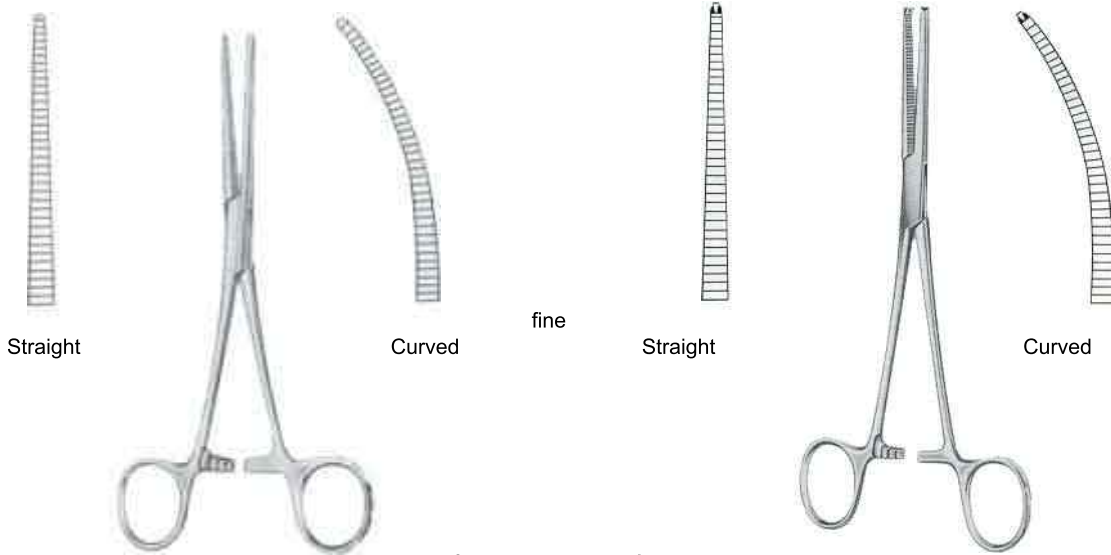

Rochester-Pean		cm	in	Ochsner-Kocher	
56-066-13	56-067-13	13.0	5"	56-068-13	56-069-13
56-066-14	56-067-14	14.0	5 1/2"	56-068-14	56-069-14
56-066-16	56-067-16	16.0	6 1/4"	56-068-16	56-069-16

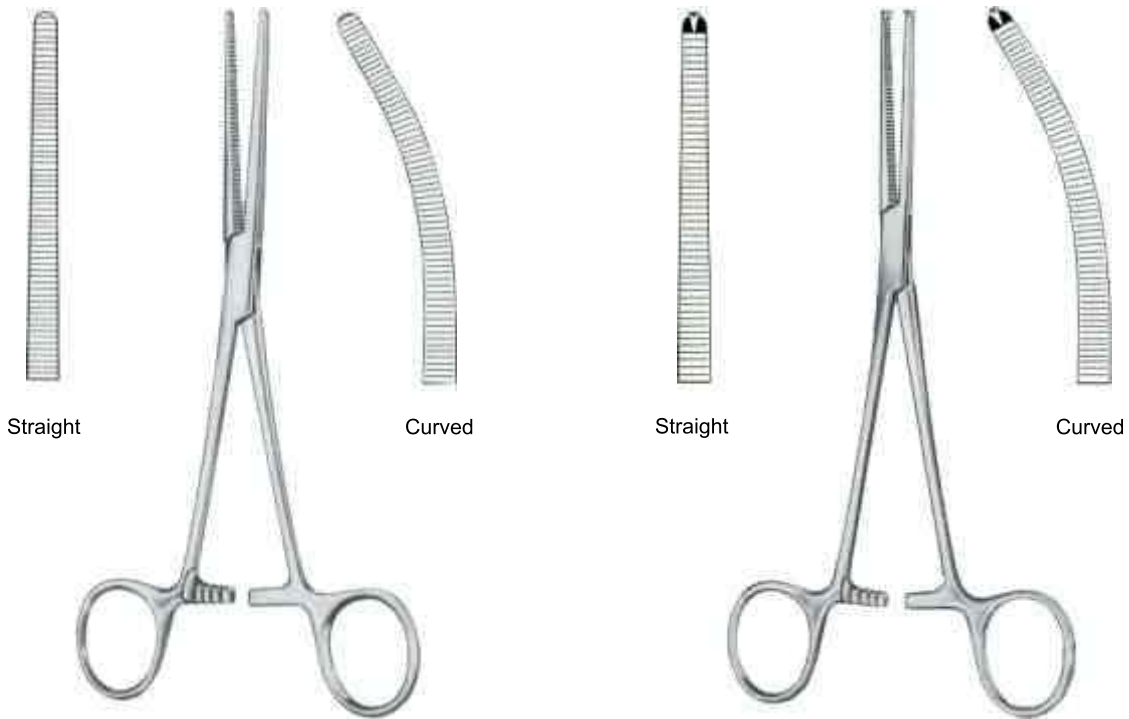

Rochester-Pean		cm	in	Ochsner-Kocher	
56-070-13	56-071-13	13.0	5"	56-072-13	56-073-13
56-070-14	56-071-14	14.0	5 1/2"	56-072-14	56-073-14
56-070-16	56-071-16	16.0	6 1/4"	56-072-16	56-073-16
56-070-18	56-071-18	18.0	7"	56-072-18	56-073-18
56-070-20	56-071-20	20.0	8"	56-072-20	56-073-20
56-070-22	56-071-22	22.0	8 3/4"	56-072-22	56-073-22
56-070-24	56-071-24	24.0	9 1/2"	56-072-24	56-073-24
56-070-26	56-071-26	26.0	10 1/4"	56-072-26	56-073-26
56-070-30	56-071-30	30.0	12"	56-072-30	56-073-30

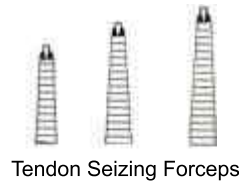

Kronlein
56-074-13
13cm/5"



Brand
56-075-15 15cm/6"
56-075-19 19cm/7 1/2"
56-075-24 24cm/9 1/2"



Brand
56-076-15 15cm/6"
56-076-19 19cm/7 1/2"
56-076-24 24cm/9 1/2"

Lateral Curved

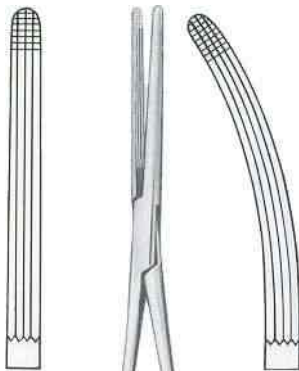

56-077-16
56-078-20

56-079-16
56-080-20



Rochester-Carmalt
16cm/6 1/4"
20cm/8"



56-081-12



Mosquito-Dandy
12cm/4 3/4"



56-082-12

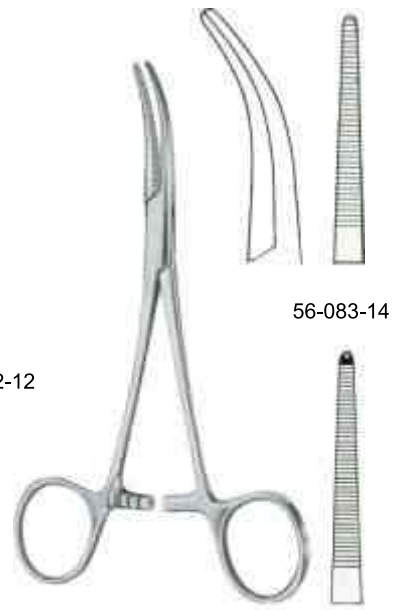

Dandy
14cm/5 1/2"

56-083-14

56-084-14



Lovelace
56-085-15
15.5cm/6"



Dixon-Lovelace
56-086-16
16cm/6¼"



Dixon-Lovelace
56-087-16
16cm/6¼"

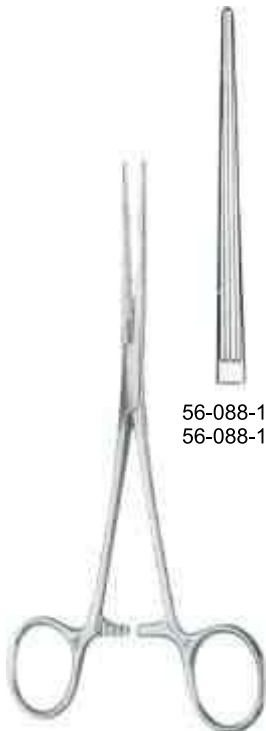

Bainbridge
15cm/6"
18cm/7"



56-088-15
56-088-18



56-089-15
56-089-18



Fuchsig
56-090-19
19cm/7½"



Adson
18.5cm/7¼"

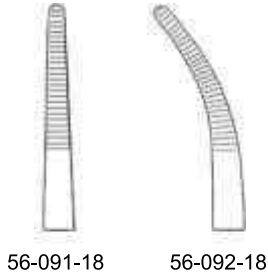

56-091-18 56-092-18

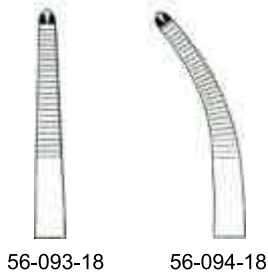

56-093-18 56-094-18



Nissen
56-095-18 18.5cm/7 ¼"
56-095-22 22.0cm/8 ¾"



Baby-Adson



56-096-14
14cm/5½"

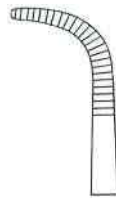

56-097-18
18cm/7"



Jacobson-Adson
18cm/7"

Very Fine



56-098-18



56-099-18



56-100-18

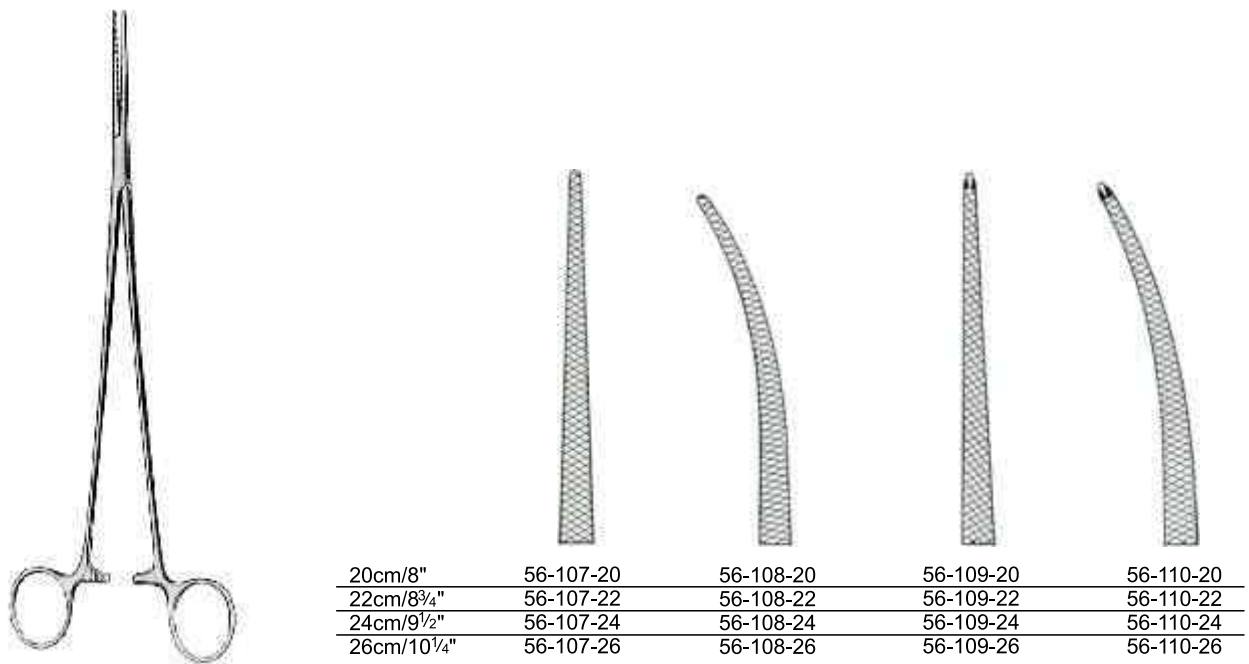
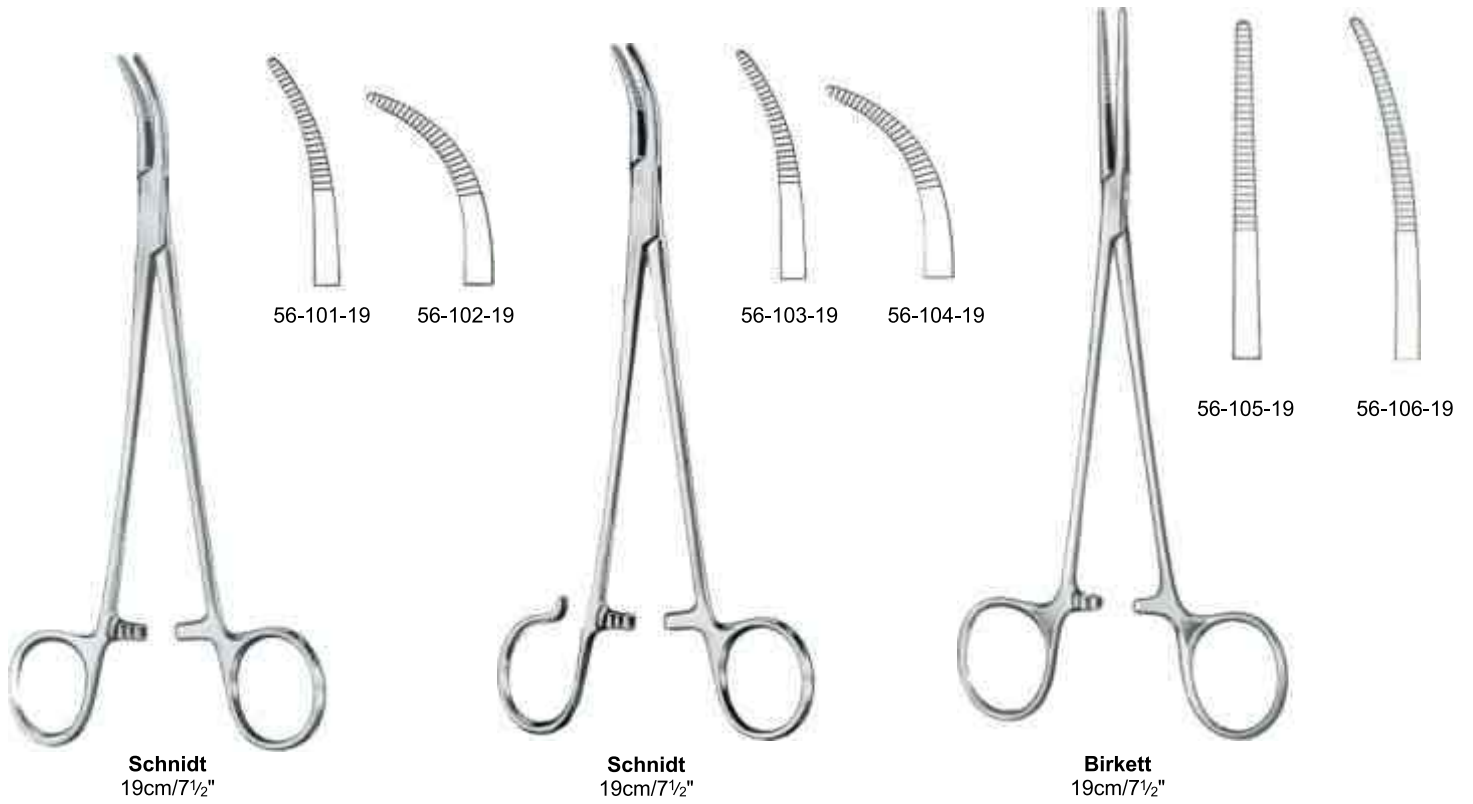



Bridge
27cm/10½"



56-111-27



56-112-27



Roberts
22cm/8¾"



56-113-22



56-114-22



Kelly

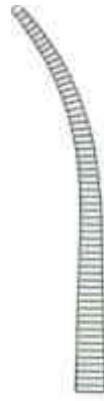

19cm/7½"
22cm/8¾"
24cm/9½"

56-115-19

56-115-22

56-115-24



56-116-19

56-116-22

56-116-24



56-117-19

56-117-22

56-117-24



Crafoord-Sellors

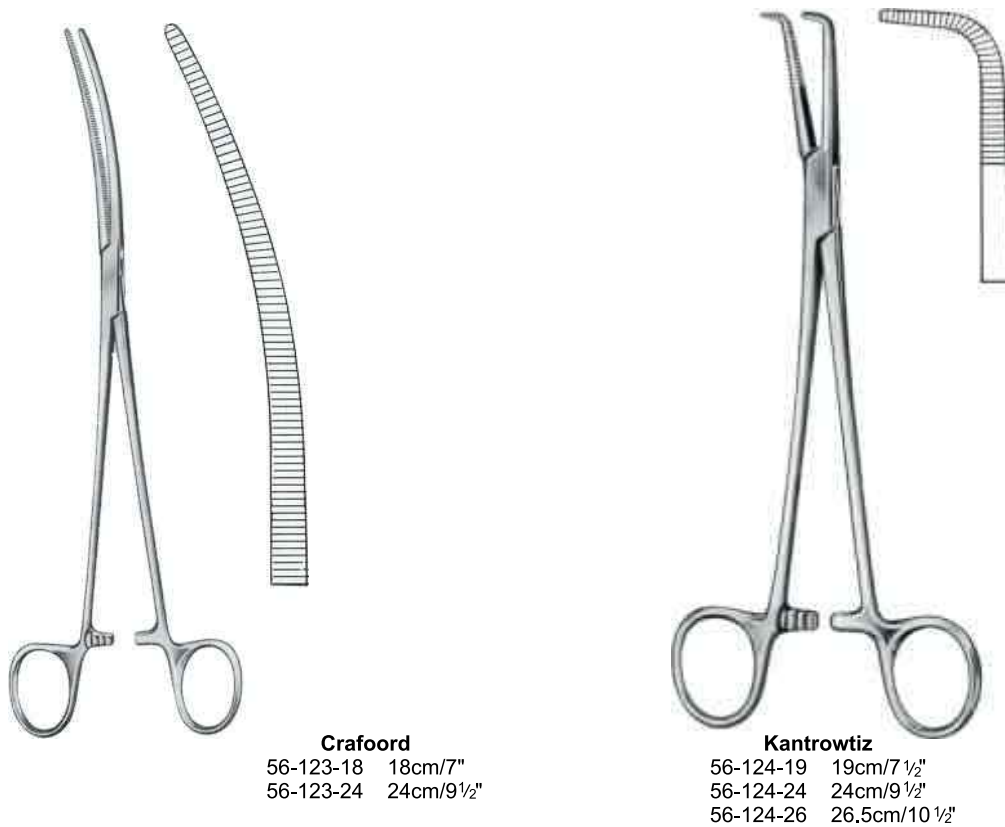



Rumel
23cm/9"



56-125-23



56-126-23



56-127-23

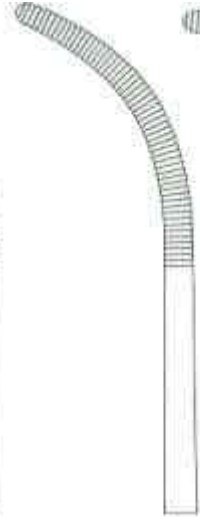

56-128-23

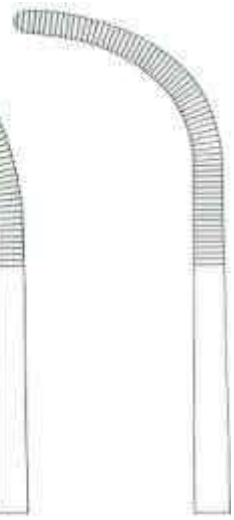

56-129-23



Johns Hopkins
56-130-20
20cm/8"



Zenker
29.5cm/11½"



56-131-29



56-132-29

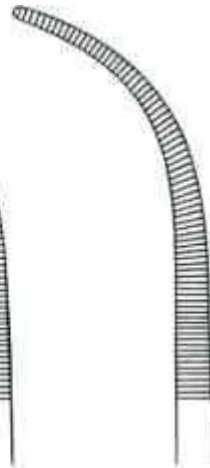

56-133-29

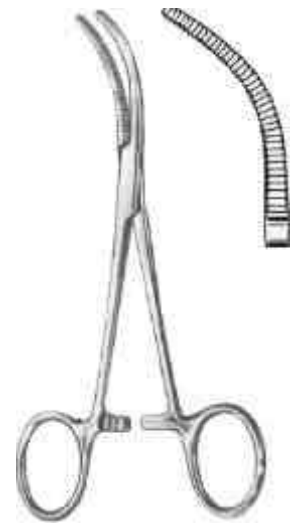

Baby-Overholt
56-134-13
13.5cm/5¼"



Overholt-Slim



56-135-18
18.5cm/7¼"

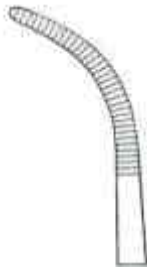

56-136-20
20.5cm/8"

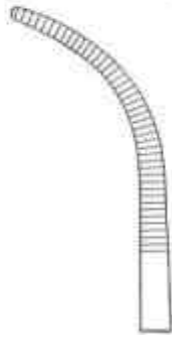

56-137-21
21cm/8¼"

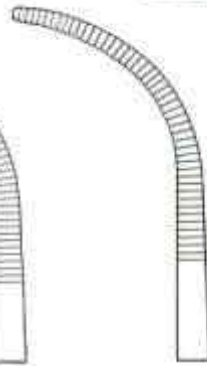

56-138-21
21.5cm/8½"

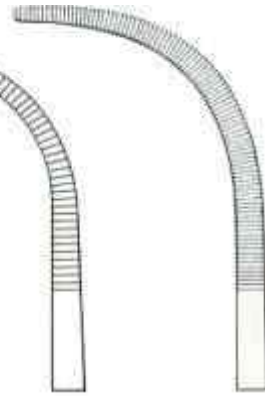

56-139-24
24cm/9½"



Overholt-Slim



56-140-18
18.5cm/7¼"



56-141-20
20.5cm/8"

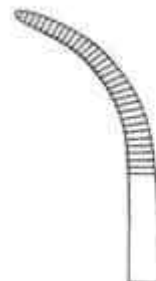

56-142-21
21cm/8¼"

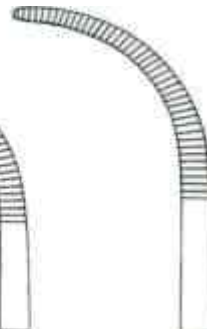

56-143-21
21.5cm/8½"





Overholt-Geissendorfer
21cm/8¼"
27cm/10½"

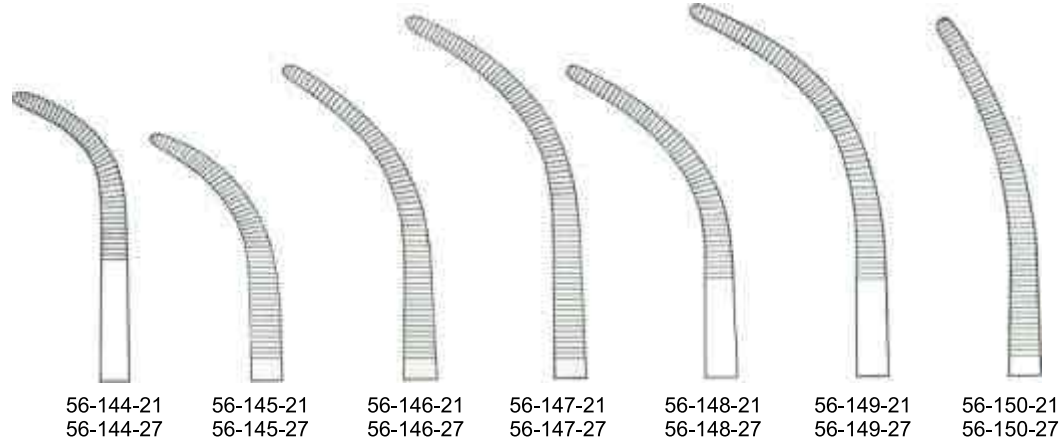

- 56-144-21
56-144-27
- 56-145-21
56-145-27
- 56-146-21
56-146-27
- 56-147-21
56-147-27
- 56-148-21
56-148-27
- 56-149-21
56-149-27
- 56-150-21
56-150-27



Overholt-Mixer
56-151-21
21cm/8¼"

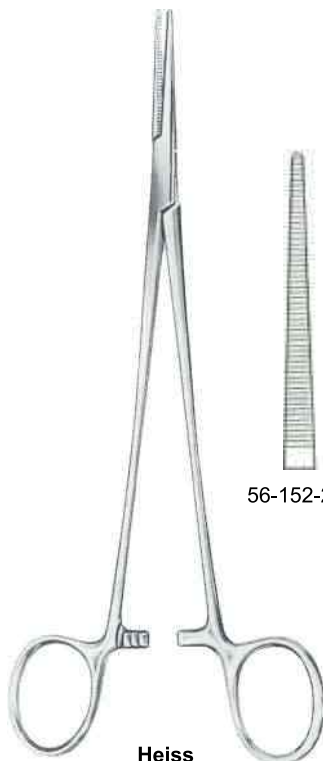

Heiss
20cm/8"

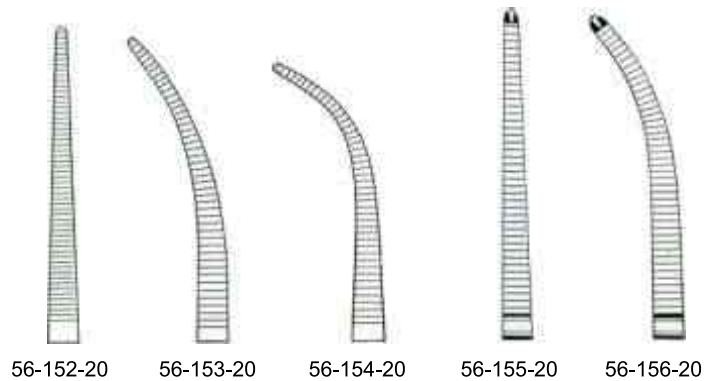

- 56-152-20
- 56-153-20
- 56-154-20
- 56-155-20
- 56-156-20



Meeker
56-157-27
27 cm/10½"

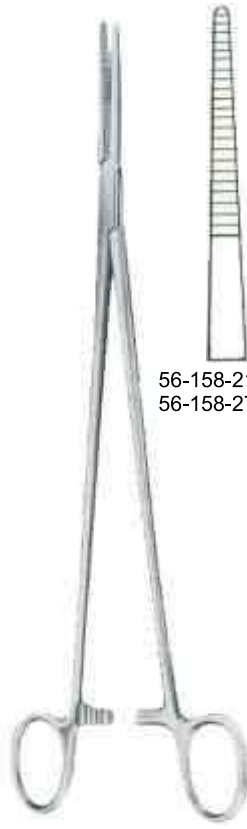

Toennis
21 cm/8¼"
26 cm/10¼"



56-158-21
56-158-27



56-159-21
56-159-27



56-160-21
56-160-27



56-161-21
56-161-27



Lower
56-162-18
18 cm/7"



Gemini



56-163-13
13 cm/5"



56-164-18
18 cm/7"



56-165-20
20 cm/8"

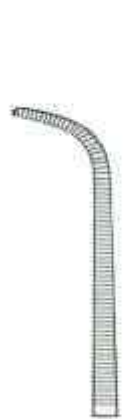

56-166-23
23 cm/9"



56-167-25
25 cm/10"

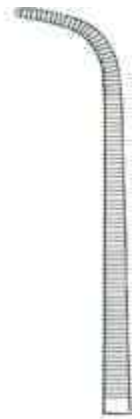

56-168-27
27 cm/10½"



Mini-Gemini

56-169-18
18 cm/7"

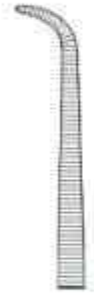

56-170-22
22 cm/8¾"

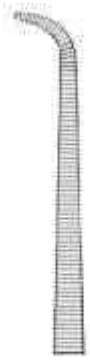

56-171-25
25 cm/10"



56-172-28
28 cm/11"

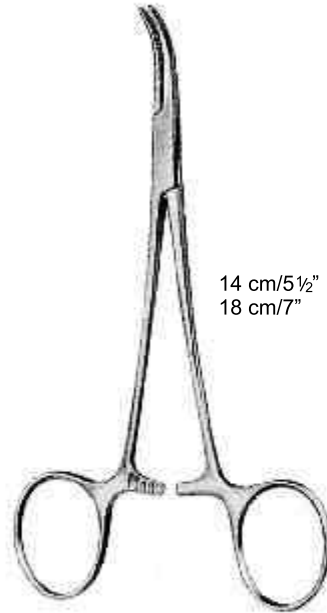

Baby-Mixer

14 cm/5½"
18 cm/7"



56-173-14
56-173-18



56-174-14
56-174-18



Mixer

56-175-15 15 cm/6"
56-175-19 19 cm/7½"



Mixer-O'Shaughnessy

56-176-15 15.5 cm/6"
56-176-19 19.0 cm/7½"

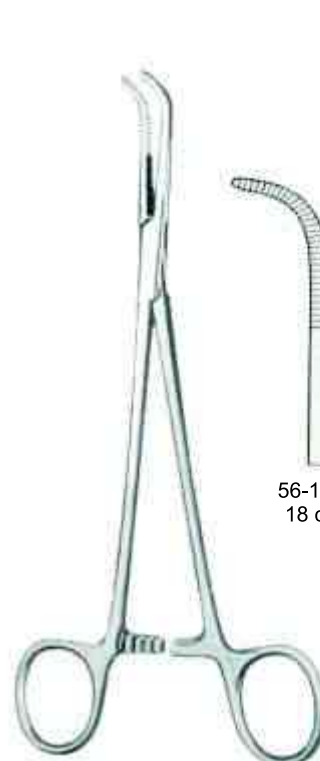

Mixer-Slim



56-177-18
18 cm/7"



56-178-23
23 cm/9"



56-179-22
22 cm/8¾"

Mixer



56-179-22
22 cm/8¾"

56-180-25
25 cm/10"

56-181-28
28 cm/11"



Mixer
56-182-22
22 cm/8¾"



Wickstroem
56-183-20
20 cm/8"



Finocchietto
56-184-24
24 cm/9½"



Mc Quigg-Mixer
56-185-22
22 cm/8¾"



Lawrence
56-186-27
27.5 cm/10¾"



Lahey (Sweet)

56-187-19
19 cm/7½"

56-188-23
23 cm/9"



Spencer-Wells

- | | | |
|-----------|----------|-----------|
| 56-189-13 | 13 cm/5" | 56-190-13 |
| 56-189-15 | 15 cm/6" | 56-190-15 |
| 56-189-18 | 18 cm/7" | 56-190-18 |
| 56-189-20 | 20 cm/8" | 56-190-20 |
| 56-189-23 | 23 cm/9" | 56-190-23 |



Spencer-Wells

- | | | |
|-----------|-----------|-----------|
| 56-191-13 | 13 cm/5" | 56-192-13 |
| 56-191-14 | 14 cm/5½" | 56-192-14 |
| 56-191-15 | 15 cm/6" | 56-192-15 |
| 56-191-18 | 18 cm/7" | 56-192-18 |
| 56-191-20 | 20 cm/8" | 56-192-20 |
| 56-191-23 | 23 cm/9" | 56-192-23 |



Rogers

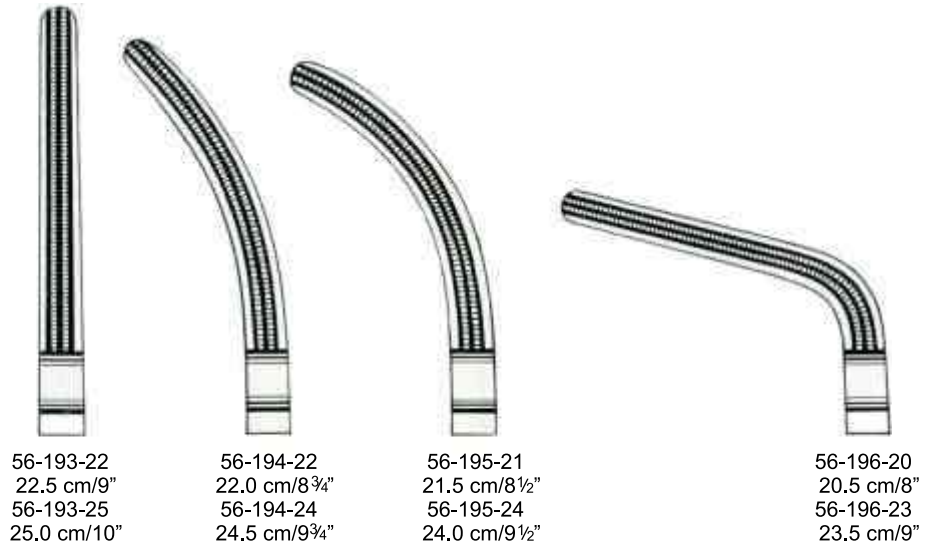

Heaney

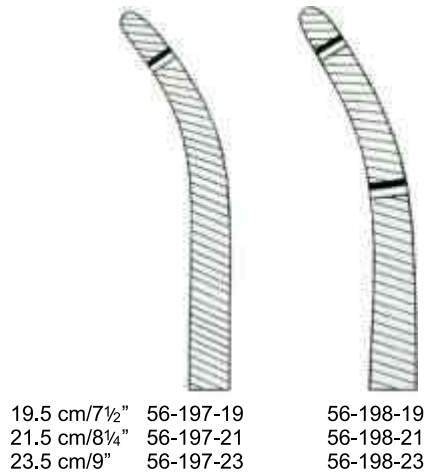

Heaney-Slim
56-199-21
21 cm/8¼"



Ballentine
56-200-21
21cm/8¼"



Heaney-Ballentine
56-201-21
21cm/8¼"



Tonsil Forceps



Fig. 1

56-202-19

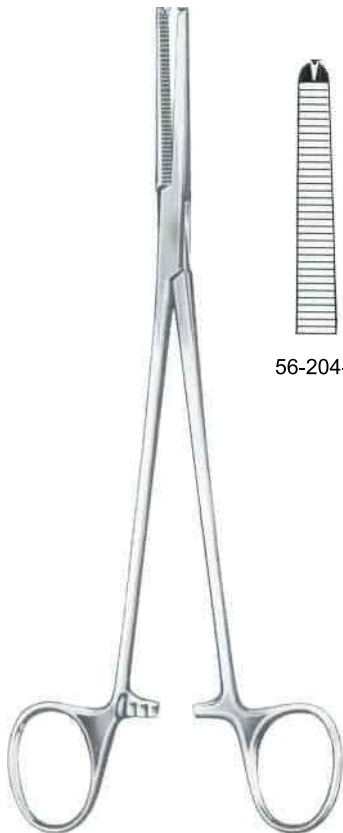

Fig. 2

Negus

19cm/7½"

56-203-19



Phaneuf
21.5cm/8½"



56-204-21

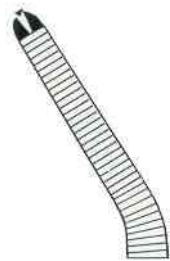

56-205-21

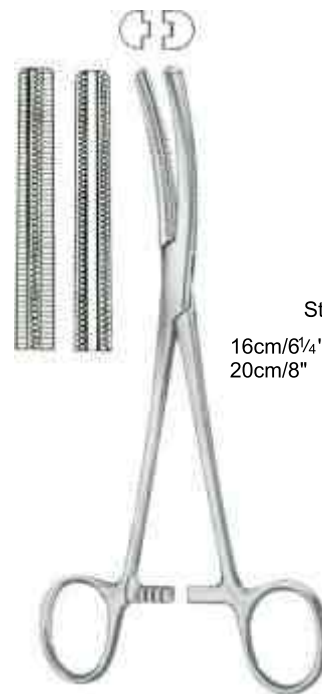

Fergusson

Haemorrhoidal Clamps



	Straight		Curved
16cm/6¼"	56-206-16	56-207-16	56-207-16
20cm/8"	56-206-20	56-207-20	56-207-20

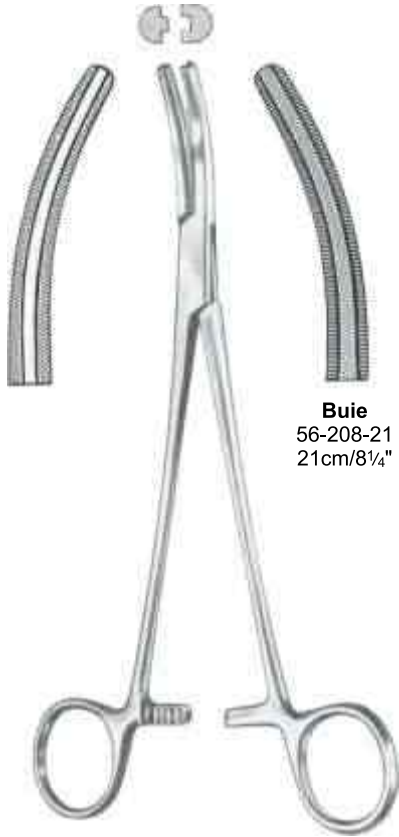

Buie
56-208-21
21cm/8¼"



Long
56-209-19
19cm/7½"



Garland
56-210-21
21cm/8¼"

Gall Duct Clamps

Hysterectomy Forceps

Pressure Clamps



56-211-23
23cm/9"



56-212-24
24cm/9½"

Moynihan



56-213-23



56-214-23

Hozlbach
23.5cm/9¼"



Zweifel
56-215-17
17.5cm/7"

Scalp Flap Forceps

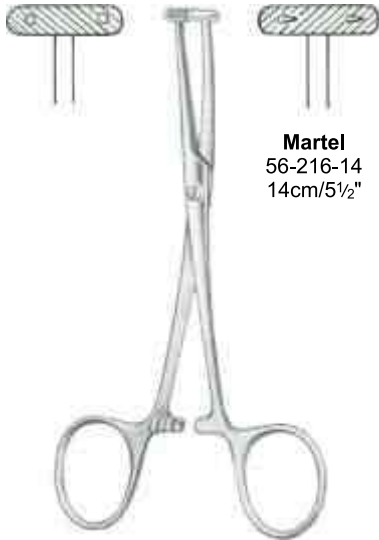

Martel
56-216-14
14cm/5½"



Wertheim
56-217-25
25cm/10"

Extra Strong



Wertheim-Cullen
56-218-21
21.5cm/8½"



Wertheim
56-219-24
24cm/9½"

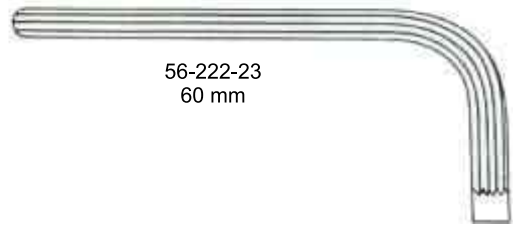
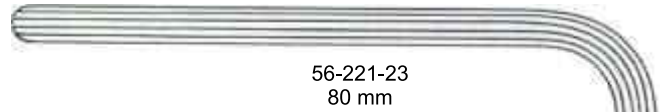
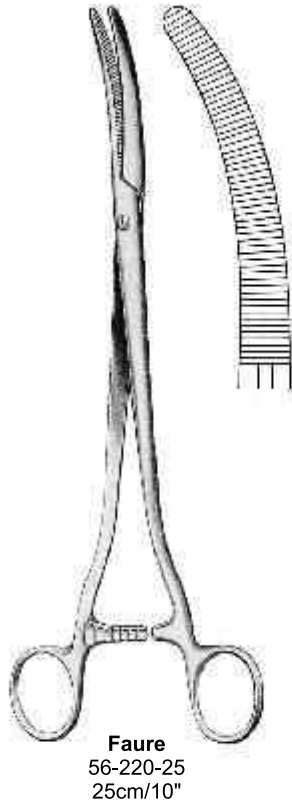



Werheim
56-226-18
18 cm/7"

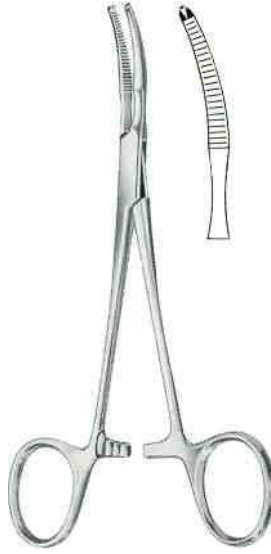

Baby-Mikulicz
56-227-14
14 cm/5½"

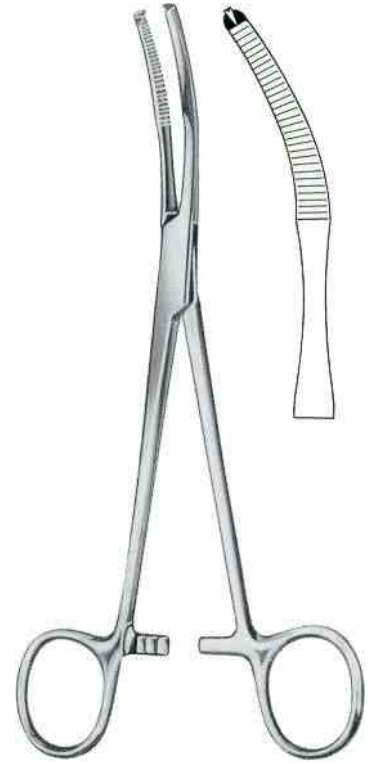

Mikulicz
56-228-18 18cm/7"
56-228-20 20cm/8"



Mikulicz
56-229-20
20 cm/8"



Mikulicz
56-230-18
18.5 cm/7¼"



Mikulicz
56-231-18
18 cm/7"



Mikulicz
56-232-20 20 cm/8" 56-233-20

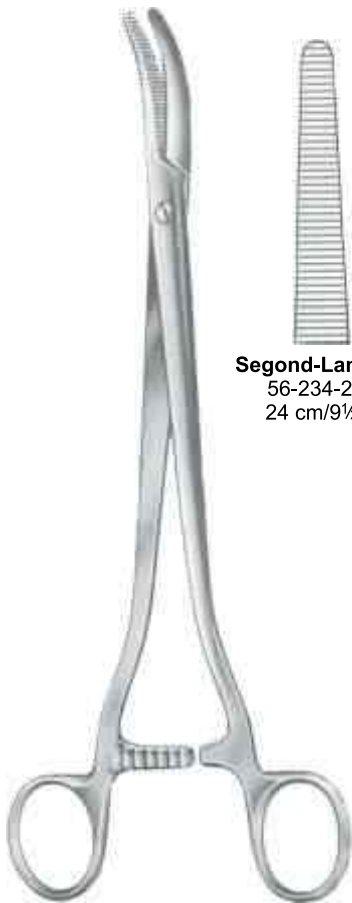
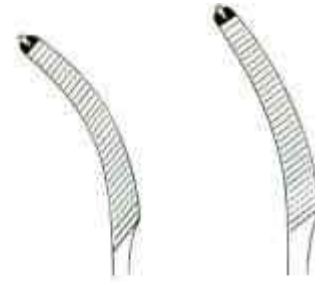

Segond-Landau
56-234-24
24 cm/9½"



Segond
56-235-24
24 cm/9½"

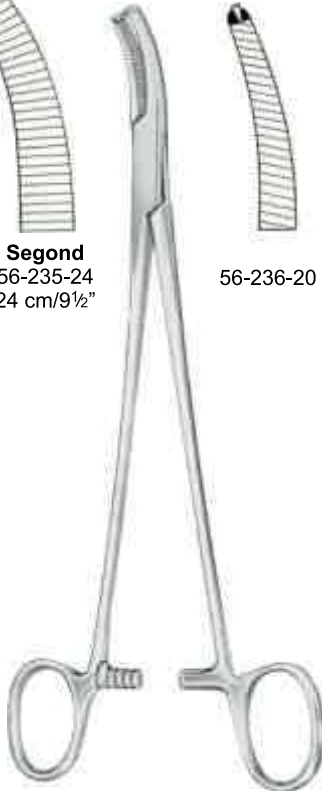

Faure
56-236-20 20 cm/8" 56-237-20



Schindler
56-238-20
20 cm/8"





Schadel
56-239-09 9 cm/3½"



Jones
56-240-05 5 cm/2"
56-240-09 9 cm/3½"



Engl-Modell
56-241-09 9 cm/3½"



Backhaus
56-242-09 9 cm/3½"
56-242-11 11 cm/4½"
56-242-13 13 cm/5"
56-242-15 15 cm/6"

With clip for Tubing or Cable



56-243-11 11 cm/4½"
56-243-13 13 cm/5"



Peers-Bertram
56-244-14 14.5 cm/5¾"



Tohoku
56-245-10 10 cm/4"
56-245-13 13 cm/5"



Roder
 56-246-13 13 cm/5"
 56-246-15 15 cm/6"



Lorna
 56-247-10 10 cm/4"
 56-247-13 13 cm/5"



Bernhard
 56-248-16 16.5 cm/6 1/2"



Lane
 56-249-20
 20 cm/8"



Doyen
 56-250-18
 18 cm/7"



56-251-14 14 cm/5 1/2"
56-251-15 15 cm/6"
56-251-18 18 cm/7"
56-251-20 20 cm/8"



56-252-14
14.5 cm/5 3/4"



56-253-16 16.5 cm/6 1/2"
56-253-18 18.0 cm/7"



56-254-15 15 cm/6"
56-254-18 18 cm/7"
56-254-20 20 cm/8"



Mohr
56-255-50 50 mm
56-255-60 60 mm
56-255-70 70 mm
56-255-80 80 mm

Sizes
mm
13
17
20
25
30



Hoffmann
56-256-13
56-256-17
56-256-20
56-256-25
56-256-30



Hoffmann
56-257-13
56-257-17
56-257-20
56-257-25
56-257-30



Ulrich

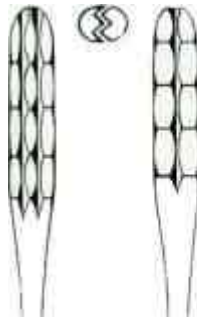

Straight

- 56-258-22
- 56-258-25
- 56-258-27



Curved

- 22 cm/8¾"
- 25 cm/10"
- 27 cm/10½"

- 56-259-22
- 56-259-25
- 56-259-27



Lister

- | | | |
|-----------|----------|-----------|
| 56-260-13 | 13 cm/5" | 56-261-13 |
| 56-260-15 | 15 cm/6" | 56-261-15 |
| 56-260-18 | 18 cm/7" | 56-261-18 |



Bryant

- 56-262-13
- 13 cm/5"

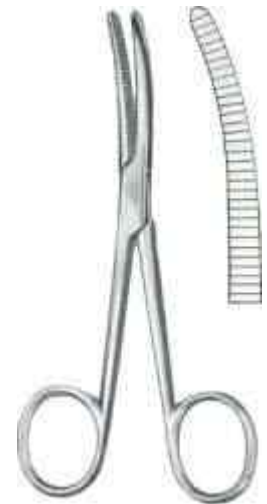

Bryant

- 56-263-13
- 13 cm/5"



Gross-Maier

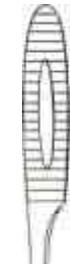

Straight



Curved

With Ratchet

56-265-20
56-265-25

20 cm/8"
25 cm/10"

56-266-20
56-266-25

Without Ratchet

56-267-20
56-267-25

20 cm/8"
25 cm/10"

56-268-20
56-268-25



Pelkmann
25 cm/10"

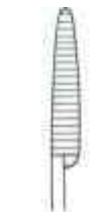

56-269-25



56-270-25

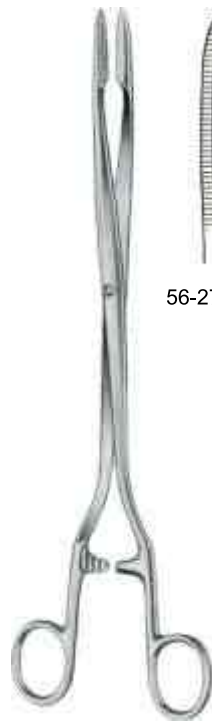

Sims-Maier
28 cm/11"



56-271-28



56-272-28

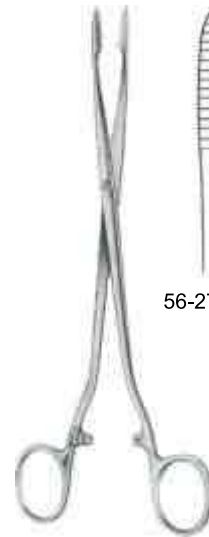

Duplay
20 cm/8"



56-273-20



56-274-20



Collin
56-275-25
25cm/10"

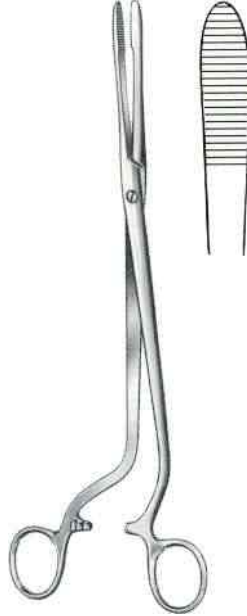

Cheron
56-276-25
25cm/10"



Emmet
56-277-21
21cm/8¼"



Bozemann
56-278-26
26cm/10¼"



Bozemann
26cm/10¼"



56-279-26



56-280-26

Smooth



Bozemann-Douglas
56-281-26 26cm/10¼"



Rampley
56-282-18 18cm/7"
56-282-24 24cm/9½"



Rampley
56-283-18 18cm/7"
56-283-24 24cm/9½"



Foerster

18 cm/7"
20 cm/8"
24 cm/9½"
25 cm/10"

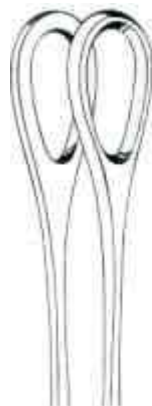

56-284-18
56-284-20
56-284-24
56-284-25

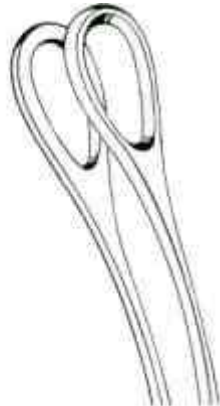

56-285-18
56-285-20
56-285-24
56-285-25



56-286-18
56-286-20
56-286-24
56-286-25

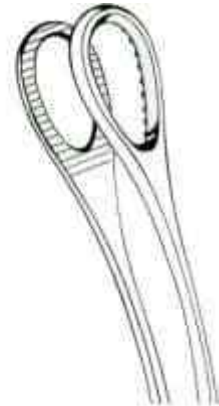

56-287-18
56-287-20
56-287-24
56-287-25



Schwartz
56-288-19
19cm/7½"



56-289-01



56-289-02



56-289-03

Applying Forceps



56-290-23
23cm/9"

Atrauma



Diethrich

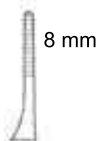

56-291-08

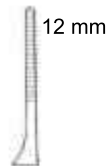

56-292-12



56-293-20

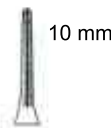

56-297-10



56-298-14



56-299-20



56-294-08



56-295-12

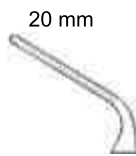

56-296-20



56-300-10



56-301-14



56-302-20

